

RADA OUTLOOK

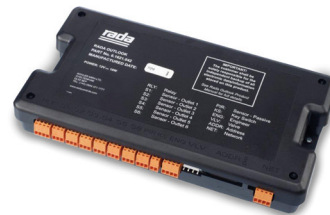

- Cost effectively and flexibly manage your water systems whilst complying with legislative requirements
- Rada Outlook is a six outlet digital thermostatic mixing valve, with programmable timed flow for hand washing and showering applications operated by a choice of non-touch or touch sensors or non-touch spout.
- Automatically performs duty flush at intervals specific for your installation
- Integrate auxiliary products such as a fan, pump or Passive Infra Red (PIR) occupancy sensor to the Outlook system and program specifically to your own application
- Records automatic duty flush and supervised thermal disinfection data for legislation compliance
- Easily program Rada Outlook using Windows based menus from your desktop, laptop or equivalent for easy access, download and interrogation of data
- Connect multiple Rada Outlook units to your IT Network or Building Management System by making Modbus data available for systems integrators to link into. Up to 31 Rada Outlook units on each Modbus network
- Incorporating T-Logic™ Digital Intelligence used in Rada Sense allowing the user to operate, communicate and exchange information with the mixing valve to deliver the ultimate in safety, hygiene and control
- Save time, resource and ultimately money when managing your water systems



T-logic™ Digital Intelligence

Allows the user to operate, communicate and exchange information with the mixing valve to deliver the ultimate in safety, hygiene and control.

Dimensions (mm)

Outlook Mixer Valve

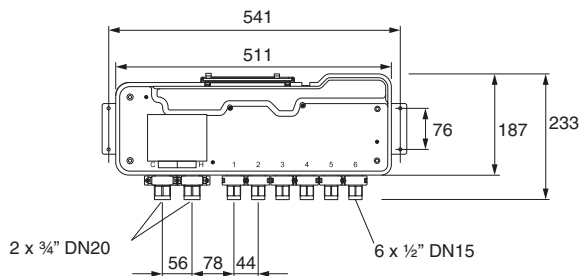

Sensor Box

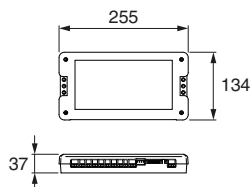

Power Supply

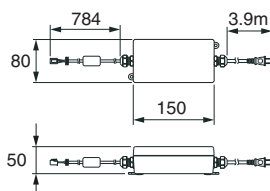

Specify as: Rada Outlook (1.1621.099)

Concealed digital thermostatic mixing valve and sensor box for hand washing and/or showering, offering programmable maximum, minimum and default temperatures, duty flush and supervised thermal disinfection with data-logging capabilities.

Supplied complete with power supply, check valves and strainers. Note: Please see following details of required and optional components to create an Outlook system.

Flow Diagram

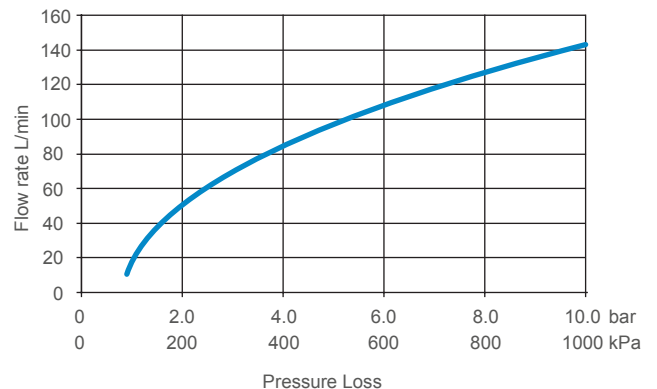

RADA OUTLOOK - REQUIRED & OPTIONAL COMPONENTS

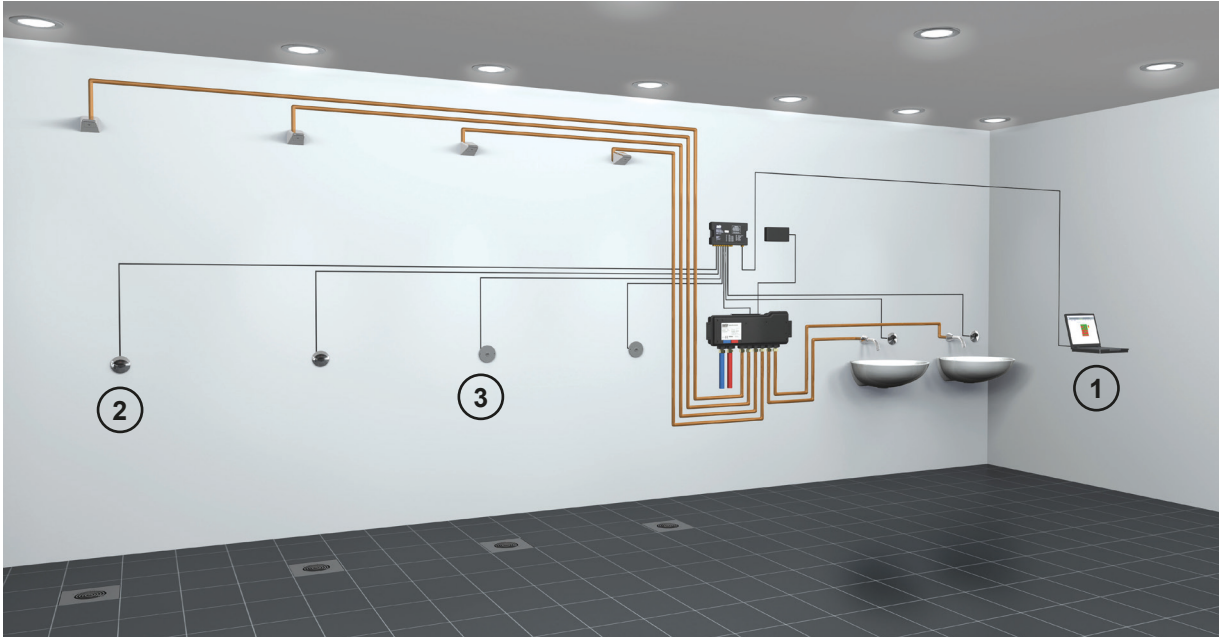

for illustration purposes only

In addition to Rada Outlook (1.1621.099) on page 1, the following items are either required or optional to create an Outlook system.

Required Items

Dimensions (mm)

- ①



Specify as: Rada Outlook RS485 Converter and Software (1.1621.117)
Easy to program configuration of outlet settings, duty flush and thermal disinfection.
Access to usage information, RS485 cable to connect the Sensor Box to a laptop/PC to enable setup.

- ②

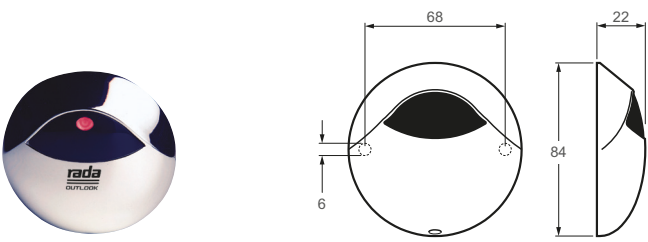

Specify as: Rada Outlook IR Sensor (1.1621.112)
Wall mounted 'non-touch' flow control. Complete with concealed active infra red sensor and 6 m cable.
The sensor should be mounted on a flat smooth surface (e.g. centre of a tile) to prevent water ingress.
The sensor is mounted via 2 fixing points, the cover conceals the wall fixings and is fitted with a security screw to prevent unwanted tampering.

- ③

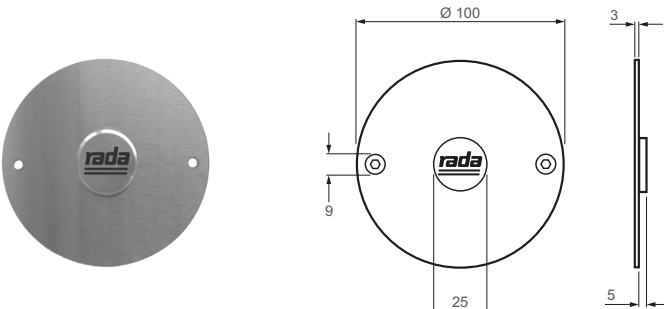

Specify as: Rada Outlook Piezo Hand Sensor (1.1621.085)
Wall mounted Piezo 'touch' flow control sensor with 3 m cable.
The sensor should be mounted on a flat smooth surface (e.g. centre of a tile) to prevent water ingress.
The sensor is mounted via 2 fixing points on the metal plate.

RADA OUTLOOK - REQUIRED & OPTIONAL COMPONENTS

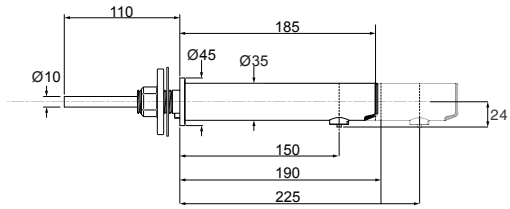
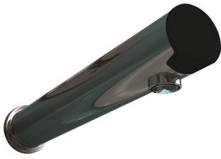

Specify as: Rada Outlook Panel Mounted IR Spout
 Non-touch infra-red sensor spout in 150 mm, 190 mm or 225 mm lengths.
 150 mm IR Spout: 1.1621.136
 190 mm IR Spout: 1.1621.132
 225 mm IR Spout: 1.1621.137

Optional Items



Specify as: Rada Outlook Outlet By-Pass Adaptor (1.1621.115)
 To channel an unused outlet to an open outlet. Useful when there are less than six outlets utilised. Eliminates water 'dead spots' where bacteria can spread.



Specify as: Rada Outlook RS485 Socket (1.1621.116)
 RS485 cable to connect the RS485 Converter to a Sensor Box within a network. The network is then accessible via laptop/PC at that point.



Specify as: Rada Relay Box (2.1495.044)
 For use with the Rada Outlook Sensor Box to provide three switched relays for operation of pumps, lights and fans.



Specify as: Rada Isolating Key Switch (2.1495.080)
 For temporary disablement of Rada Outlook Sensor Box during cleaning or maintenance of showering.

For complementary Rada Shower Heads and Basin Spouts please refer to www.radacontrols.com

Operational Schematic

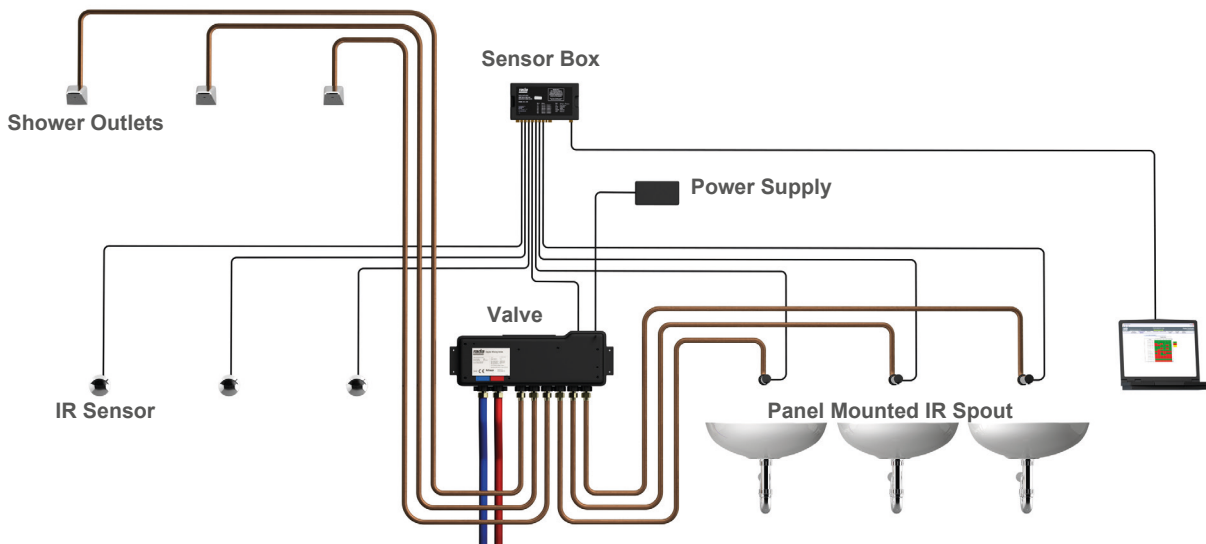

Illustration shows a basic 6 outlet set-up for Rada Outlook, consisting of three showers and three wash basins

TECHNICAL SPECIFICATION

Installation and Maintenance

Please refer to the appropriate product manual.

Connections

Flat faced union connections.

Approvals

WRAS approved (Water Regulations Advisory Scheme)
BEAB approved
Designed, manufactured and supported in accordance with accredited
BS EN ISO 9001:2008 Quality Management Systems and
BS EN ISO 14001:2004 Environmental Management Systems

Operation

Sensor flow control: Non-touch ON/OFF. Touch ON/OFF.
Non-touch ON/OFF spout.

Materials

Mixing unit enclosure: PC/ABS.
Integral components: DZR brass, stainless steel, engineering plastic.

Temperature Range

Factory pre-set: Default 38°C.
Programmable range: Min 30°C - 47°C, Max 33°C - 50°C and Default
30°C - 50°C at start up, or full cold only can be selected.
Minimum blend temperature differential from hot supply: 2°C.
Optimum thermostatic control range: 30°C - 50°C.
Cold water range (recommended): 1°C - 20°C
Hot water range (recommended): 50°C - 65°C (85°C Max. - during
disinfection).
Temperature stability: $\pm 1^\circ\text{C}$ for recommended supply conditions.

Pressures

Maximum static pressure: 8 bar (800 kPa).
Minimum pressure loss: 1.5 bar (150 kPa) Refer to Note.
Hot and cold pressure should be nominally equal.
(Max differential 3:1 either way).
Minimum flow rate per outlet: <5 bar maintained pressure 6 l/min,
>5 bar maintained pressure 8 l/min.

Note! The pressure loss of a system (valve and outlet fitting) is the average of the two inlet pressures minus the back pressure, where the back pressure is determined by the flow resistance of any outlet fitting.

Environment

Ambient temperature: 1°C - 40°C.
Maximum relative humidity: 95% non-condensing.
Suitable for indoor use only.

IP Rating

Mixer Valve: IP24.
Sensor Box: IP20.
PSU: IP45.

Electrical Specification

Supply Voltage: 100 - 240 V RMS 50 - 60 HZ. 1.5 A
Maximum load: 40 W at 12 V DC.
Valve to sensor box cable length: 1.5m
Sensor box to sensor cable length: IR - 6m.
Piezo - 3m

Flow Times and Duty Flush

Factory settings
Flow time: 30 seconds.
Duty flush cycle: 2 minutes.
Duty flush waiting period: 3 days.
Programmable range
Flow time: 5 sec - 60 min.
Duty flush cycle: 1 min - 59 min.
Duty flush waiting period: 1 hr - 983 hrs.
Duty flush not enabled at factory, programming required.

Disinfection

Factory settings - Standard
Target time: 5 minutes.
Max Warm Up: 1 min.
Timeout: 10 mins.
Target temperature: 60°C.

Programmable range

Temperature: 60°C - 80°C.
Time: 1 - 59 minutes.

Configuration Tool

A Laptop/PC is required to adjust factory settings, retrieve data, configure duty flush and disinfection cycles.
The programmer software available is designed to run on Microsoft Windows XP/Vista operating systems.

Please refer to the appropriate software manual.

Sensor Box

Web enabling on-line approach and linking on building management network is possible, or sensor box can be linked directly to Building Management System (BMS), via Modbus.

Features

Connections for 6 control sensors
Connect to multiple sensor boxes in a network* (Modbus)
Connection for motion (safety) PIR
Connection for ventilation circuit

* Maximum number of sensor boxes in a single network = 31

For the latest guidance please refer to the Approved Code of Practice, The Control of Legionella Bacteria in Water Systems (L8).

Kohler Mira Limited
Cromwell Road, Cheltenham
Gloucestershire, GL52 5EP

Specification Enquiries
Tel: 0844 571 1777, Fax: 0844 472 3076
Email: rada_technical@mirashowers.com
www.radacontrols.com

Rada is a registered trademark of Kohler Mira Limited.
The company reserves the right to alter product specification without notice.
© June 2016 Kohler Mira Limited. All rights reserved.
No part of this document, or any accompanying document, may be reproduced or transmitted in any form or by any means, including photocopying or electronically, without the permission of Kohler Mira Limited.

A **KOHLER** COMPANY



FM 14648

